

Item no.: 771-9985/207-701
Product description: CONNECTION WIRE; PLUG - OPEN WIRE; 5 POLE; 7 m;
CODING I; e. g. for dimming function (DALI)

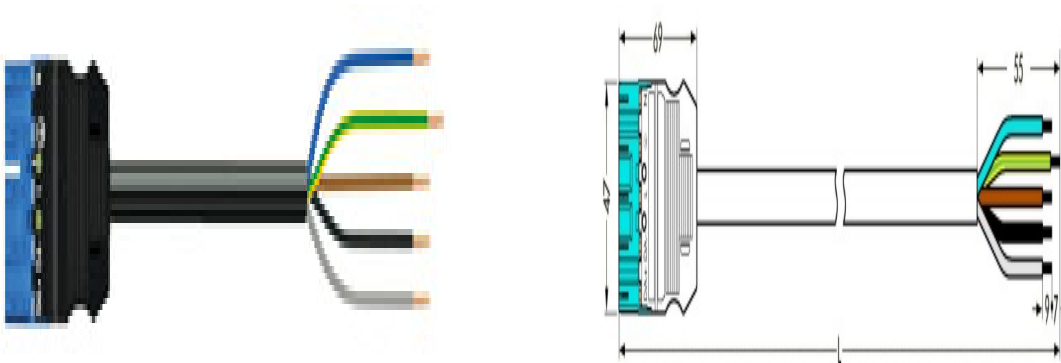

Packing unit 1 piece

Product group	20 (WINSTA)
pole count	5
Cross section to [mm ²]	2,5 mm ²
Cross section to [AWG]	14 AWG
Number of strands	5
Measured voltage EN	400 V
Measured shock voltage	6 kV
Pollution degree	3
Current intensity EN	20 A
Weight	1719,482 g
Color	black

© WAGO Kontakttechnik GmbH & Co. KG

Specifications are subject to changes and errors may be expected